

## UNIVERZÁLIS ZÁRLEMEZ KICSI

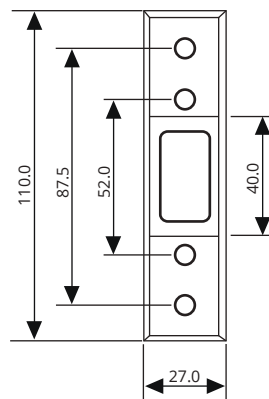

Kód		
PMCP.IP5M	250 db.	14.655

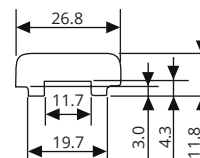

## UNIVERZÁLIS ZÁRLEMEZ NAGY

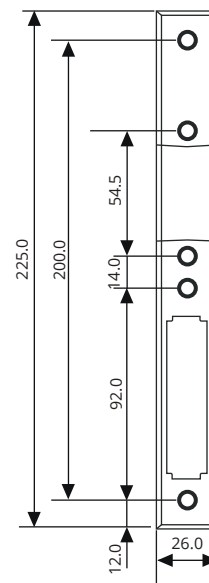

Kód		
PMCP.IPBG	100 db.	12.869

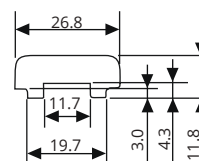

## PM ZÁRLEMEZ PORTÁLZÁRHOZ

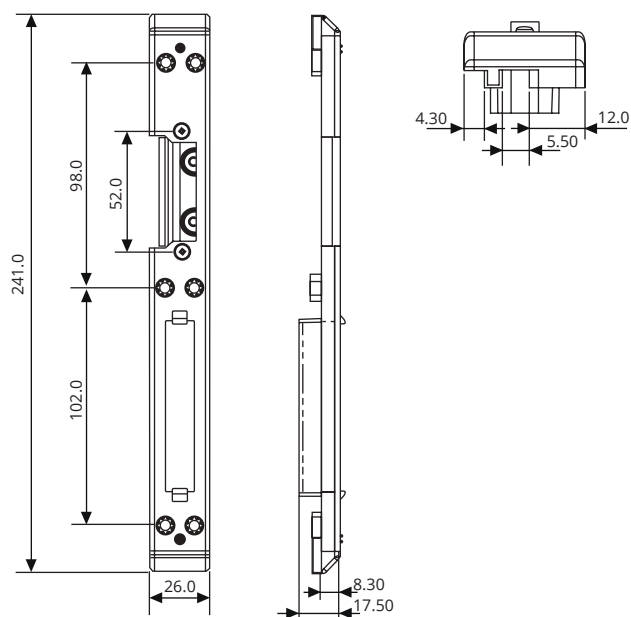

Kód			
PMCP.IPSSL.DL	100 db.	13.600	BALOS
PMCP.IPSSL.DR	100 db.	13.600	JOBBOS

## PM ZÁRLEMEZ RÚDZÁRRA

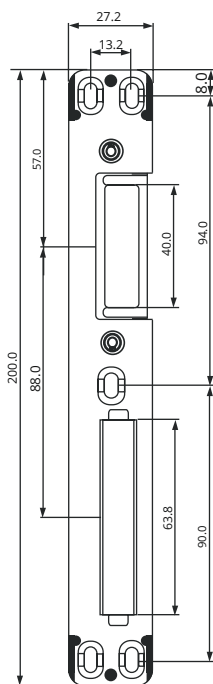

Kód			
PMCP.ARML.DL	50 db.	13.600	BALOS
PMCP.ARML.DR	50 db.	13.600	JOBBOS
PMCP.ARSP.MM	300 db.	0.693	ADAPTER STULP PROFILRA
PMCP.ARSP.AL	300 db.	0.577	ADAPTER ALUPLAST
PMCP.ARSP.GL	300 db.	0.577	ADAPTER GEALAN
PMCP.ARSP.KB	300 db.	0.577	ADAPTER KBE
PMCP.ARSP.KM	300 db.	0.577	ADAPTER KOMMERLING
PMCP.ARSP.NT	300 db.	0.693	ADAPTER INOUTIC
PMCP.ARSP.RH	300 db.	0.577	ADAPTER REHAU

Kód			
PMCP.ARSP.RP	300 db.	0.577	ADAPTER ROPLASTO
PMCP.ARSP.SC	300 db.	0.577	ADAPTER SCHUCO
PMCP.ARSP.SL	300 db.	0.577	ADAPTER SALAMANDER
PMCP.ARSP.VK	300 db.	0.577	ADAPTER VEKA

## PM TOLÓRETESZ AJTÓHOZ



Kód		
PMDBD.AR150	50 db.	7.875

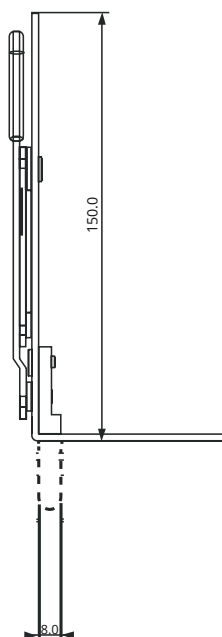

## ELEPHANT TOLÓRETESZ ABLAKHOZ



Kód		
PMDBW.PL120	50 db.	3.557

\*\*\*\*\* - SZÍN

WH - FEHÉR

LB - VILÁGOSBARNA

DB - SÖTÉTBARNA

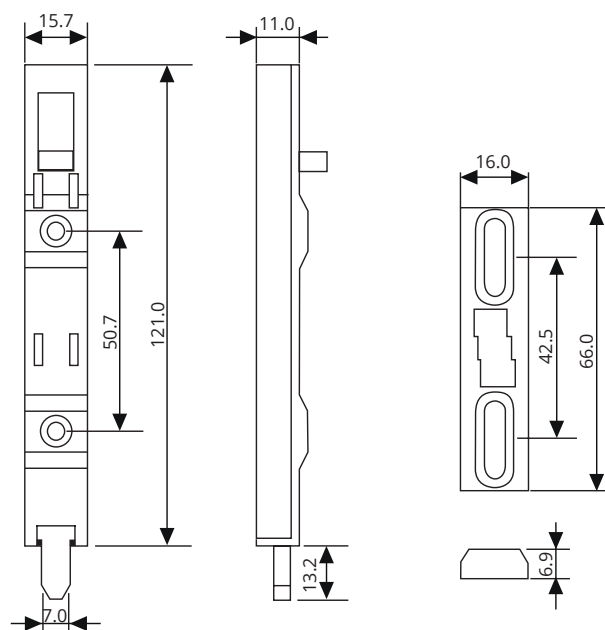

### CSAVAR MEREVÍTŐ VASHOZ 3.9\*16

Kód			A	B
PMEJ.SCST-3.9X16	1000 db.	9.365	∅ 3.9	16 mm

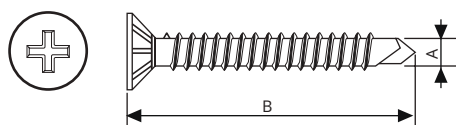

### CSAVAR MEREVÍTŐ VASHOZ 3.9\*19

Kód			A	B
PMEJ.SCST-3.9X19	1000 db.	11.850	∅ 3.9	19 mm

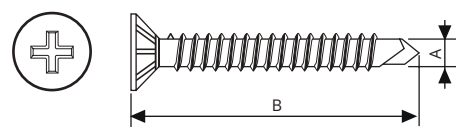

### CSAVAR MEREVÍTŐ VASHOZ 3.9\*25

Kód			A	B
PMEJ.SCST-3.9X25	1000 db.	12.380	∅ 3.9	25 mm

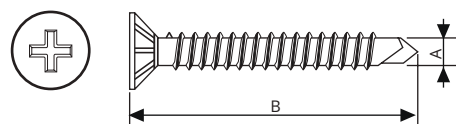

### CSAVAR MEREVÍTŐ VASHOZ 3.9\*38



Kód			A	B
PMEJ.SCST-3.9X38	1000 db.	16.559	ø 3.9	38 mm

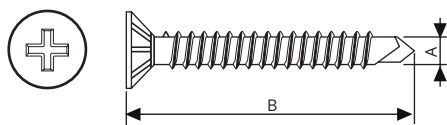

### CSAVAR VASALATHOZ 4.1\*25



Kód			A	B
PMEJ.SCHR-4.1X25	1000 db.	13.520	ø 4.2	25 mm

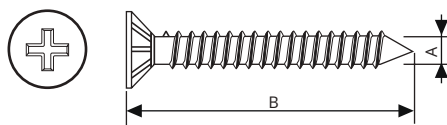



### CSAVAR ZSANÉRHOZ 4.2/3.5\*37

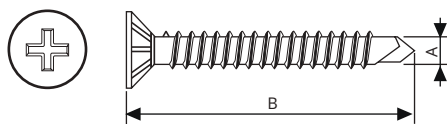

Kód			A	B
PMEJ.SCHG-4.2X37	1000 db.	22.160	ø 4.2	37 mm



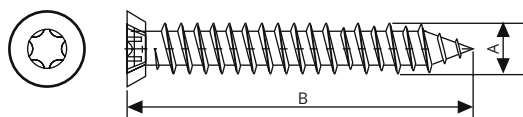

## RÖGZÍTŐ CSAVAR

Kód			A	B
PMPL.SCAS-7.5X08	100 db.	1.641	ø 7.5	80 mm
PMPL.SCAS-7.5X10	100 db.	2.040	ø 7.5	100 mm
PMPL.SCAS-7.5X12	100 db.	2.500	ø 7.5	120 mm
PMPL.SCAS-7.5X15	100 db.	3.400	ø 7.5	150 mm
PMPL.SCAS-7.5X18	100 db.	3.750	ø 7.5	180 mm

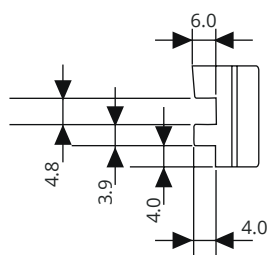
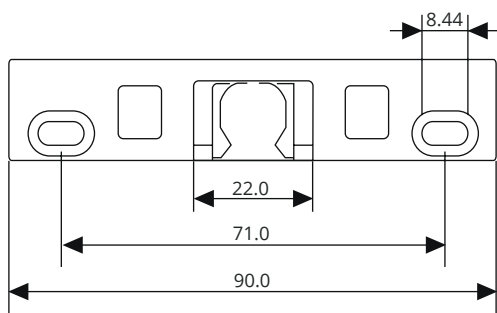

## PM ZÁRFOGADÓ ERKÉLYAJTÓRA 13 AKS



Kód		
PM.SKBKDR.FR	100 db.	5.448

## PM ZÁRFOGADÓ STULP PROFILRA



Kód		
PM.SKGL02.MM	250 db.	8.522

## PM REHAU ZÁRFOGADÓ



Kód		
PM.SKRH01.FR	750 db.	11.488

## ALUMÍNIUM ROVARHÁLÓ PROFIL



Kód		
PMAL.PR1625.**	20 db. * 6 méter	18.250

\*\*\*\*\* - SZÍN

WH - FEHÉR

LB - VILÁGOSBARNÁ

DB - SÓTÉTBARNÁ

## ALUMÍNIUM PROFIL 20\*40



Kód		
PMAL.PR2040.**	10 db. * 6 méter	19.885

\*\*\*\*\* - SZÍN

WH - FEHÉR

LB - VILÁGOSBARNÁ

DB - SÓTÉTBARNÁ

